

## Features

## Unregulated Converters

- Fully RoHS 6/6 Conform
- Full Power at 85°C Ambient Temperature
- 1kVDC and 3kVDC Isolation Options
- /H Version Certified for Medical Applications
- UL/EN/CSA Certified, CB Report
- Suitable for Fully Automated Assembly (including Vapour Phase Soldering)
- Optional Continuous Short Circuit Protection
- Efficiency to 85%
- Built-In EN55022 Class A Filter

### Description

The R2S and R2D converters are of the enclosed open frame type, meaning that they are unpotted. The converters are typically used in general purpose and industrial low power isolation and voltage matching applications where an SMD converter is required. The converter series feature an extended ambient temperature operating range of -40°C ~ +85°C without de-rating and optional continuous short circuit protection. In addition to two isolation options and three different case formats, the converters are also available prepacked as tape and reel for use with automatic insertion machines.

### Selection Guide

Part Number	SMD	(3kV)	Input Voltage (VDC)	Output Voltage (VDC)	Output Current (mA)	Efficiency (%)	Max Capacitive Load <sup>(1)</sup>
R2S**-xx3.3	(H)		5, 12, 15, 24	3.3	606	70-75	3300µF
R2S**-xx05	(H)		5, 12, 15, 24	5	400	76-84	1200µF
R2S**-xx09	(H)		5, 12, 15, 24	9	222	76-84	1200µF
R2S**-xx12	(H)		5, 12, 15, 24	12	167	76-85	680µF
R2S**-xx15	(H)		5, 12, 15, 24	15	133	76-85	680µF
R2S**-xx24	(H)		5, 12, 15, 24	24	83	76-85	220µF
R2D**-xx05	(H)		5, 12, 15, 24	±5	±200	75-80	±470µF
R2D**-xx09	(H)		5, 12, 15, 24	±9	±111	75-80	±470µF
R2D**-xx12	(H)		5, 12, 15, 24	±12	±83	75-83	±330µF
R2D**-xx15	(H)		5, 12, 15, 24	±15	±66	75-85	±330µF
R2D**-xx24	(H)		5, 12, 15, 24	±24	±42	75-85	±330µF

xx = Input Voltage. Other input and output voltage combinations available on request.

\* add Suffix "P" for Continuous Short Circuit Protection, e.g. R2S-0505/P, R2D-0505/HP

\* add suffix -R for tape&reel packing e.g. R2S-0505-R. For more details see Tapes Section.

### Case and Pinning Options (note restrictions on /H option)

- R2S\*\* : \*\* without marking denotes 5 pins out of 8 fitted (/H option available)  
 \*\* with marking **8** denotes 8 pins out of 8 fitted (/H option not available)  
 \*\* with marking **12** denotes 10 pins out of 12 fitted (/H option available)
- R2D\*\* : \*\* without marking denotes 6 pins out of 10 fitted (/H option available)  
 \*\* with marking **10** denotes with 10 pins out of 10 fitted (/H option not available)  
 \*\* with marking **12** denotes with 10 pins out of 12 fitted (/H option available)

### Specifications (measured at T<sub>A</sub> = 25°C, nominal input voltage, full load and after warm-up)

Input Voltage Range		±10%
Output Voltage Accuracy		±5%
Line Voltage Regulation		1.2%/1% of Vin max.
Load Voltage Regulation (10% to 100% full load)	3.3V output types	20% max.
	5V output type	15% max.
	9V, 12V, 15V, 24V output types	10% max.
Output Ripple and Noise (20MHz limited)		150mVp-p max.
Operating Frequency		20kHz min. / 40kHz typ. / 85kHz max.
Efficiency at Full Load		70% min. / 80% typ.
Minimum Load = 0%	Specifications valid for 10% minimum load only.	

cont.

## ECONOLINE

DC/DC-Converter

with 3 year Warranty

# RECOM

## 2 Watt

## SMD Single & Dual Output



**UL-60950-1 Certified**  
**EN-60950-1 Certified**  
**EN-60601-1 Certified\***  
 (\* /H suffix)

# R2S-R2D

Refer to Application Notes

### Specifications - Continued

Isolation Voltage	(tested for 1 second)	1000VDC	
	(rated for 1 minute)	500VAC / 60Hz	
Isolation Voltage	(rated for 1 second)	3000VDC	
	(rated for 1 minute)	1500VAC / 60Hz	
Isolation Capacitance		115pF max.	
Isolation Resistance	(Viso 500V)	10 GΩ min.	
Short Circuit Protection		1 Second	
P-Suffix		Continuous	
Operating Temperature Range (free air convection)		-40°C to +100°C (see Graph)	
Storage Temperature Range		-55°C to +125°C	
Reflow Temperature	ROHS compliant	245°C (30 sec), peak 255°C (5 sec) max.	
Vapour Phase Process	(for more details see Application Notes)	230°C (90 sec) max.	
Relative Humidity		95% RH	
Package Weight	R2S, R2S8	1.4g	
	R2D, R2D10	1.5g	
	R2S12, R2D12	1.6g	
Packing Quantity	R2S, R2S8	39 pcs per Tube	
	R2S12, R2D, R2D10, R2D12	33 pcs per tube	
	All Types	250 pcs per Reel	
MTBF (+25°C)	} Detailed Information see Application Notes chapter "MTBF"	using MIL-HDBK 217F	886 x 10 <sup>3</sup> hours
(+85°C)		using MIL-HDBK 217F	128 x 10 <sup>3</sup> hours

#### Certifications

CB Test Report	Report: US/14402/UL	
UL General Safety	Report: E308085	UL 60950-1 2nd Ed.
CUL General Safety		C22.2 No. 60950-1-03
EN General Safety		EN-60950-1 2nd Ed.
EN Medical Safety	Report: MDD1205098-2 + RM1205098-2	IEC/EN 60601-1 3rd Ed.
	Medical Report + ISO14971 Risk Assessment	
EN General Safety	Report: LVD 1005061	EN60950-1: 2006 2nd Ed. +A11:2009
Conducted / Radiated Emissions	EN55022	Level A

#### Notes

Note 1 Maximum capacitive load is defined as the capacitive load that will allow start up in under 1 second without damage to the converter.

## Derating-Graph (Ambient Temperature)

### R2S-0505, R2D-0505

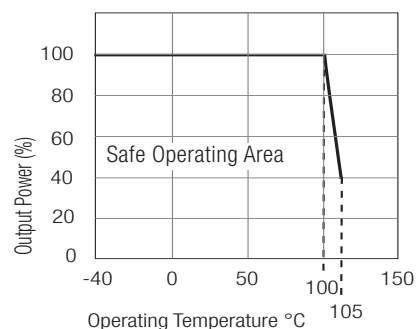

The derating graph is valid only for the shown part numbers.

## R2S-xx05

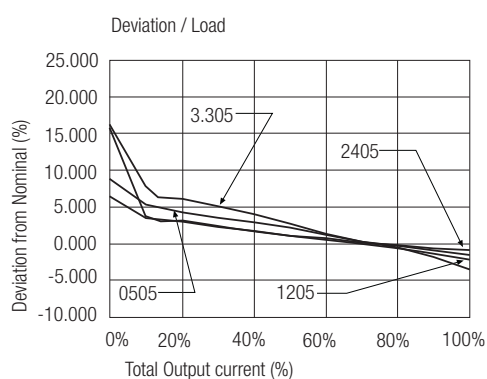
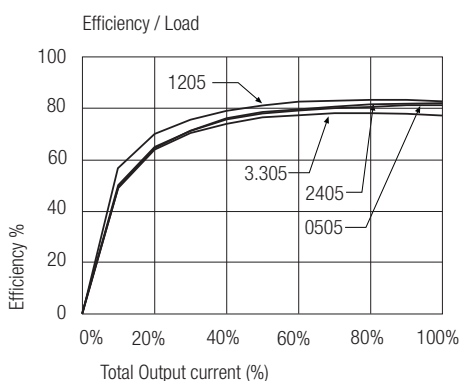

## R2D-xx05

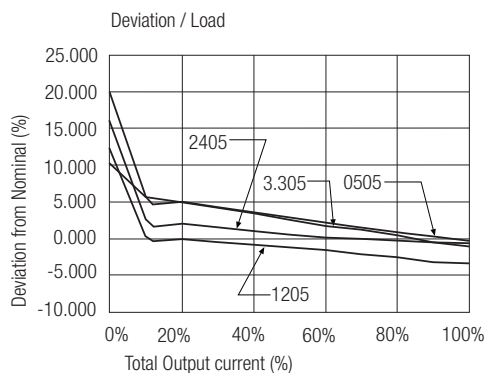
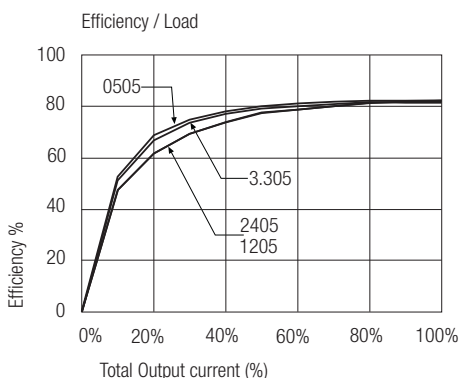

# ECONOLINE

DC/DC-Converter

# R2S & R2D Series

## EMC Filtering - Suggestion for EN55022 Class B (Conducted and Emitted)

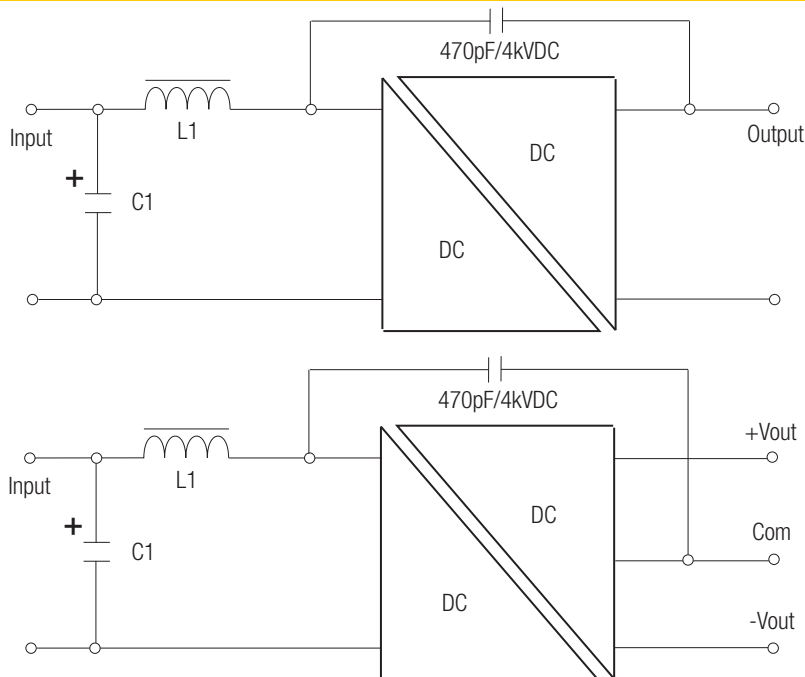

Standard and /H versions

C1	L1	Vin
4.7µF	3.3µH	3.3V
2.2µF	4.7µH	5V
2.2µF	10µH	9V
2.2µF	10µH	12V
2.2µF	22µH	15V
4.7µF	22µH	24V

/P and /HP versions

C1	L1	Vin
10µF	4.7µH	3.3V
10µF	10µH	5V
4.7µF	22µH	9V
4.7µF	22µH	12V
4.7µF	22µH	15V
10µF	47µH	24V

C1 = MLCC

L1 = SMD Inductor

## Package Style and Pinning (mm)

8 PIN Single SMD Package

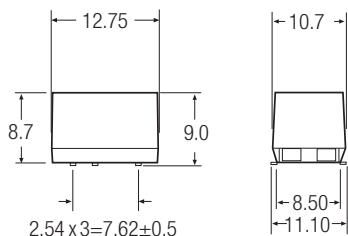

10 PIN Dual SMD Package

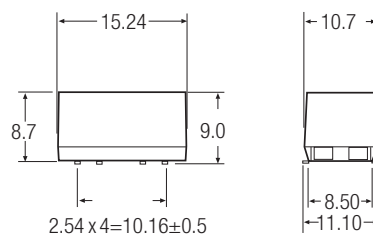

Recommended Footprint Details

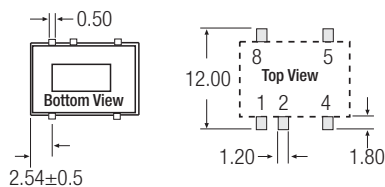

Pin Connections

Pin #	Single	Dual
1	-Vin	-Vin
2	+Vin	+Vin
4	-Vout	Com
5	+Vout	-Vout
7	No Pin	+Vout
8	NC	No Pin
10	No Pin	NC

NC = No Connection

XX.X ± 0.5 mm

XX.XX ± 0.25 mm

Recommended Footprint Details

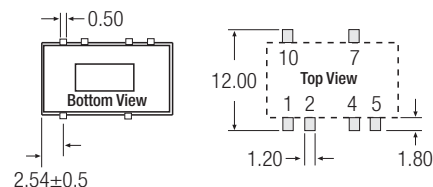

R2S\*\* : \*\* without marking denotes 5 pins out of 8 fitted (includes /H option)  
 \*\* with marking **8** denotes 8 pins out of 8 fitted (/H option not available)

e.g. R2S-0505, R2S-0505/H, R2S-0505/HP  
 e.g. R2S8-0505, R2S8-0505/P

R2D\*\* : \*\* without marking denotes 6 pins out of 10 fitted (includes /H option)  
 \*\* with marking **10** denotes with 10 pins out of 10 fitted (/H option not available)

e.g. R2D-0505, R2D-0505/H, R2D-0505/HP  
 e.g. R2D10-0505, R2D10-0505/P

### Package Style and Pinning (mm)

#### Full 8 PIN Single SMD Package

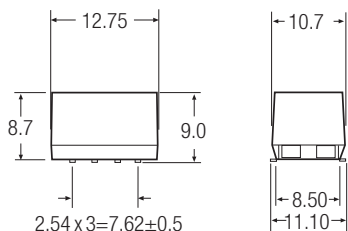

Note: /H option is not available in these pin packages

#### Full 10 PIN Dual SMD Package

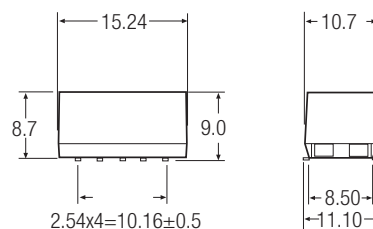

#### Recommended Footprint Details

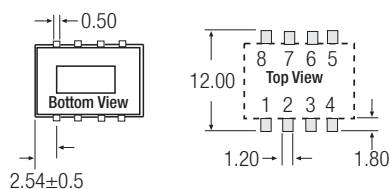

#### Pin Connections

Pin #	Single	Dual
1	-Vin	-Vin
2	+Vin	+Vin
3	NC	NC
4	-Vout	Com
5	+Vout	-Vout
6	NC	NC
7	NC	+Vout
8	NC	NC
9	-	NC
10	-	NC

NC = No Connection

XX.X ± 0.5 mm

XX.XX ± 0.25 mm

#### Recommended Footprint Details

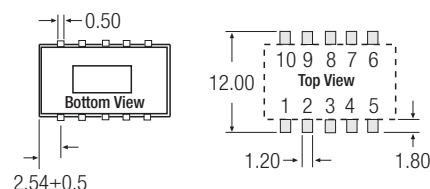

#### 12 PIN Single and Dual SMD Package

Note: /H option is available in this pin package

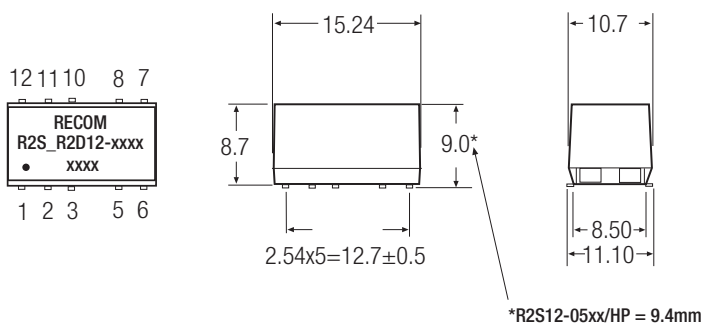

#### Pin Connections

Pin #	Single	Dual
1	-Vin	-Vin
2	+Vin	+Vin
3	NC	NC
5	-Vout	Com
6	NC	-Vout
7	NC	NC
8	+Vout	+Vout
10	NC	NC
11	NC	NC
12	NC	NC

NC = No Connection

XX.X ± 0.5 mm

XX.XX ± 0.25 mm

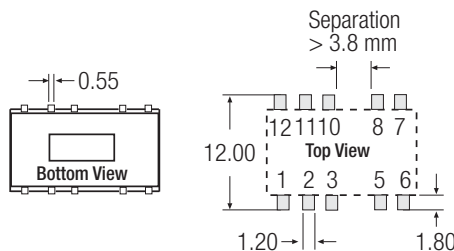

#### Recommended Footprint Details

R2S\*\*: \*\* with marking 12 denotes 10 pins out of 12 fitted (includes /H option)

R2D\*\*: \*\* with marking 12 denotes 10 pins out of 12 fitted (includes /H option)

e.g. R2S12-0505, R2S12-0505/H, R2S12-0505/HP

e.g. R2D12-0505, R2D12-0505/H, R2D12-0505/HP