

RoHS  **875 Series Fuse, Lead-free 3.6 x 10 mm, Slo-Blo® Fuse**



Agency	Agency File Number	Ampere Range
	E10480	0.100A - 10 A

Description

Single Pigtail Axial Lead 3.6x10mm, Slo-Blo Fuse

Features

- Designed to UL/CSA 248 Standard
- Slo-Blo, ceramic body fuse in a compact package
- Single Pigtail Axial Lead format
- Pb-free, RoHS Compliant
- Available in ratings of 0.10 to 10 Amperes

Applications

This space saving fuse is ideally suited for lighting, power supply, and adapter applications.

Electrical Characteristics

% of Ampere Rating	Opening Time
100%	4 hours, Minimum
200%	60 seconds, Maximum

Electrical Characteristics

Amp Code	Ampere Rating (A)	Voltage Rating (V)	Interrupting Rating	Nominal Cold Resistance (Ohms)	Nominal Melting I ² t (A ² sec)	Agency Approvals
						
.100	0.100	250	50A @ 250 VAC	2.900	0.0054	x
.125	0.125	250		1.850	0.0072	x
.200	0.200	250		0.920	0.0165	x
.250	0.250	250		0.6575	0.038	x
.300	0.300	250		0.435	0.043	x
.400	0.400	250		0.321	0.136	x
.500	0.500	250		0.256	0.288	x
.600	0.600	250		0.151	0.611	x
.800	0.800	250		0.116	0.919	x
001.	1.00	250		0.095	1.503	x
01.5	1.50	250		0.0519	4.33	x
01.6	1.60	250		0.0476	5.08	x
002.	2.00	250		0.02887	8.45	x
02.5	2.50	250		0.02246	17.85	x
003.	3.00	250		0.0171	24.50	x
004.	4.00	250		0.0135	42.45	x
005.	5.00	250		0.00954	60.90	x
006.	6.00	250		0.00891	72.30	x
007.	7.00	250		0.008	106.80	x
008.	8.00	250		0.0077	134.59	x
010.	10.00	250	0.00675	208.00	x	

Notes:
Cold resistance measured at less than 10% of rated current at 23°C.

Temperature Derating Curve

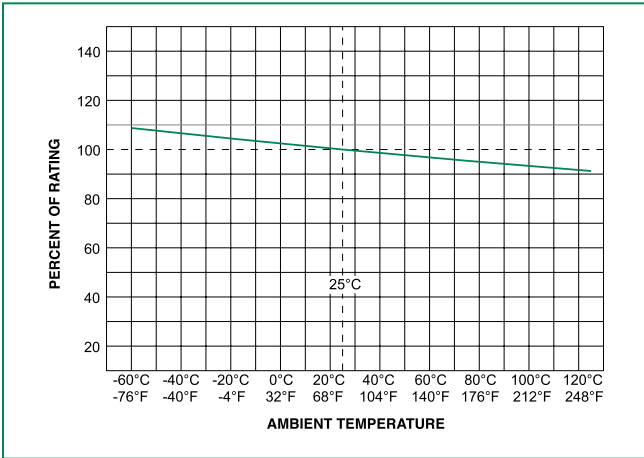

Average Time Current Curves

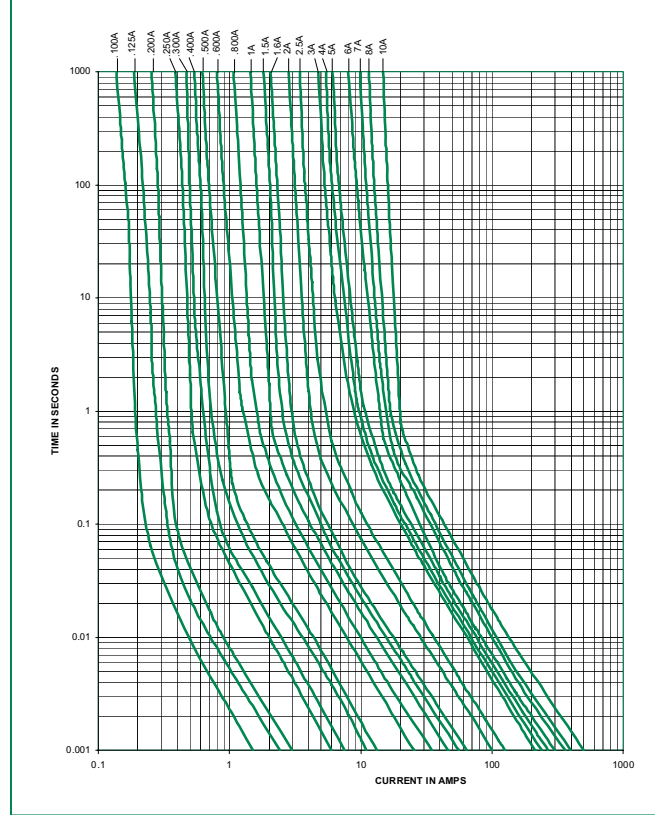

Soldering Parameters - Wave Soldering

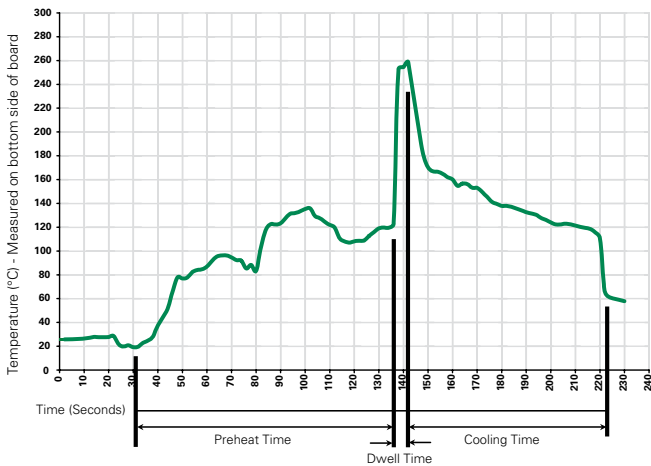

Recommended Process Parameters:

Wave Parameter	Lead-Free Recommendation
Preheat: (Depends on Flux Activation Temperature)	(Typical Industry Recommendation)
Temperature Minimum:	100° C
Temperature Maximum:	150° C
Preheat Time:	60-180 seconds
Solder Pot Temperature:	260° C Maximum
Solder Dwell Time:	2-5 seconds

Recommended Hand-Solder Parameters:

Solder Iron Temperature: 350° C +/- 5° C
 Heating Time: 5 seconds max.

Note: These devices are not recommended for IR or Convection Reflow process.

Product Characteristics

Materials	Body: Ceramic Cap: Nickel Plated Brass Tin Plated Copper
Terminal Strength	MIL-STD-202F Method 211A, Test Condition A
Solderability	Reference IEC 60127 Second Edition 2003-01 Annex A
Product Marketing	Body: Brand Logo, Current Rating Characteristic "T"; Agency approval marks
Packaging	Bulk (1000 pcs/pkg) Tape & Reel (1000 pcs/reel)

Operating Temperature	-55°C to 125°C
Thermal Shock	MIL-STD-202F, Method 107G Test Condition B3 (5 cycles -65°C to +125°C)
Vibration	MIL-STD-202F, Method 201A (10-55 Hz)
Humidity	MIL-STD-202, Method 106, High Humidity (90-98%RH), Heat (65°C)
Salt Spray	MIL-STD-202F, Method 101D, Test Condition B

Dimensions

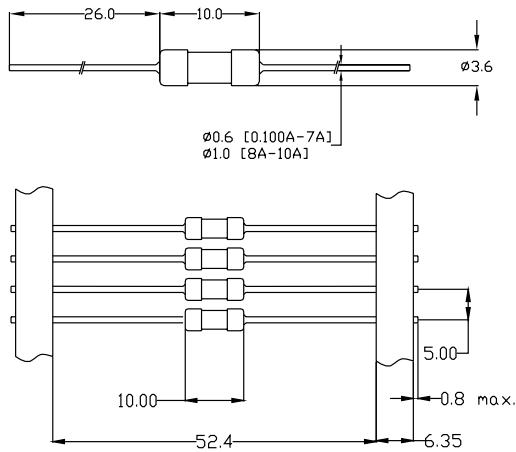

All dimensions in mm

Part Numbering System

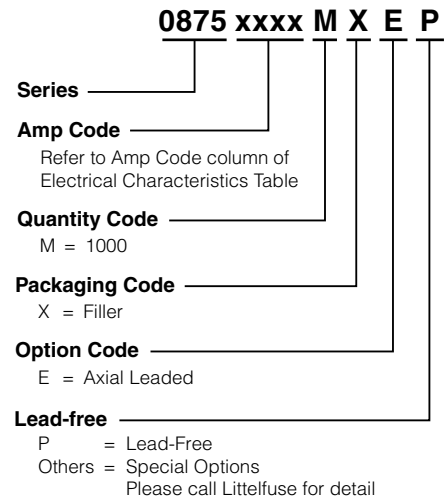

Packaging

Packaging Option	Packaging Specification	Quantity	Quantity & Packaging Code	Taping Width
875 Series				
Bulk	Bulk	1000	MXE	N/A
Tape and Reel	EIA 296	1000	MRET1	T1 = 52mm (2.062")

Mouser Electronics

Authorized Distributor

Click to View Pricing, Inventory, Delivery & Lifecycle Information:

Littelfuse:

[0875006.MRET1P](#) [0875006.MXEP](#) [0875007.MRET1P](#) [0875007.MXEP](#) [0875008.MRET1P](#) [0875010.MRET1P](#)
[0875010.MXEP](#) [0875002.MRET1P](#) [0875001.MRET1P](#) [0875.300MRET1P](#) [087501.5MXEP](#) [087502.5MXEP](#)
[0875.200MRET1P](#) [087502.5MRET1P](#) [0875002.MXEP](#) [0875.800MXEP](#) [0875.600MRET1P](#) [0875.250MRET1P](#)
[0875001.MXEP](#) [0875.500MRET1P](#) [0875.400MRET1P](#) [0875003.MXEP](#) [0875.600MXEP](#) [0875.800MRET1P](#)
[0875.500MXEP](#) [0875004.MXEP](#) [0875.200MXEP](#) [0875.100MXEP](#) [0875005.MXEP](#) [087501.5MRET1P](#)
[0875.400MXEP](#) [0875.300MXEP](#) [087501.6MRET1P](#) [0875.125MRET1P](#) [087501.6MXEP](#) [0875.100MRET1P](#)
[0875005.MRET1P](#) [0875003.MRET1P](#) [0875.250MXEP](#) [0875004.MRET1P](#) [0875.125MXEP](#) [0875008.MXEP](#)